Operating instructions



TARAline sensors

CP4MA...-AT

April 2019 (EN)

V0

Table of contents

1	Information about these operating instructions.....	4
1.1	Symbols and displays	4
1.2	Associated documents	5
2	Information on this product.....	6
2.1	Product description	6
2.2	Scope of supply	7
2.3	Product overview	8
2.4	Name plate	10
3	Safety	10
3.1	Use for the intended purpose	11
3.2	Use other than for the intended purpose.....	11
3.3	Staff qualifications.....	11
3.4	Rebuilding and modifications.....	11
3.5	Residual risks	12
4	Ex-proof specifications	15
5	Commissioning.....	17
5.1	Installation requirements	17
5.2	Preparation of the sensors	18
5.3	Insertion into the flow chamber.....	20
5.4	Electrical connection	20
5.5	Initial calibration	20
6	Calibration.....	21
7	Removal	22



8	Maintenance.....	22
8.1	Maintenance overview	22
8.2	Changing the electrolyte and membrane cap.....	23
9	Troubleshooting	25
9.1	Fault overview.....	26
9.2	Special checks.....	31
10	Technical data.....	33
11	Deinstallation and storage	34
12	Disposal	34
13	Warranty.....	35
14	Liability disclaimer.....	35

1 Information about these operating instructions

1.1 Symbols and displays







1.1.1 Safety and warning instructions

The hazard symbols and signal words listed below are used in these operating instructions. They help you use the product safely, protect the operating personnel against injuries and protect the operating company against damage to property and additional costs.

	Signal word	Meaning
	DANGER!	DANGER means a hazard with a high degree of risk which if not avoided will lead to death or serious injury.
	WARNING!	WARNING means a hazard with a medium degree of risk which if not avoided may lead to death or serious injury.
	CAUTION!	CAUTION means a hazard with a low degree of risk which if not avoided may lead to minor or moderate injury.
	NOTE	NOTE warns against damage to property.

Tab. 1: Signal words

1.1.2 Labels in the text

Symbol	Meaning
	This symbol is the general warning symbol and warns you about risks of injury. Take all the actions that are indicated by this warning symbol.
	This symbol indicates tips and helpful information for optimum and economic use of the product.
	This symbol indicates actions to be performed by the personnel.
	This symbol indicates the result of an action.
	This symbol indicates individual bullet points.
	This symbol indicates a precondition before performing an action.

Tab. 2: *Labels in the text*

1.2 Associated documents

Data sheets on the individual types of sensors can be found at the following Internet address:

<http://www.reiss-gmbh.com/english/datasheets.htm>

2 Information on this product

2.1 Product description

The sensors in the TARAline CP4MA...-AT product range are 3-electrode systems with covering membranes for measuring the disinfectant chlorine dissolved in water in ex-proof areas. The area of application of these sensors comprises swimming baths or water with qualities similar to those of drinking water.

The sensors are not suitable for checking for the absence of chlorine.

The sensor measures the concentration of total chlorine in the water being measured, resulting from the application of inorganic chlorine products (such as chlorine gas, sodium hypochlorite solution, calcium hypochlorite solution).

The following types of chlorine are recorded:

- “Free chlorine” made up of inorganic chlorination products (chlorine gas, hypochlorite, etc.)
- “Bonded chlorine”, chloramine.

The sensor has a greatly reduced pH dependency.

A complete measuring and/or control system normally consists of the following components:

- Sensor
- Zener barrier
- Electrical leads and connectors
- Flow chambers and connections
- Measuring and control device
- Dosing equipment
- Analytical equipment



These operating instructions relate exclusively to the sensor.

- ▷ Comply with the operating instructions for the peripheral devices.

2.2 Scope of supply

- ▶ Keep the all the packaging for the sensor.
- ▶ In the event of repair or warranty please return the sensor in the original packaging.
- ▶ Check that the delivery is complete and undamaged.

If it is damaged:

- ▶ Please contact your supplier.

Component	Quantity
Sensor with membrane cap	1
Electrolyte	1 bottle
mA-hood with O-Ring 20 x 1.5	1
Special emery paper	1
Operating instructions	1

Tab. 3: Scope of supply

2.3 Product overview

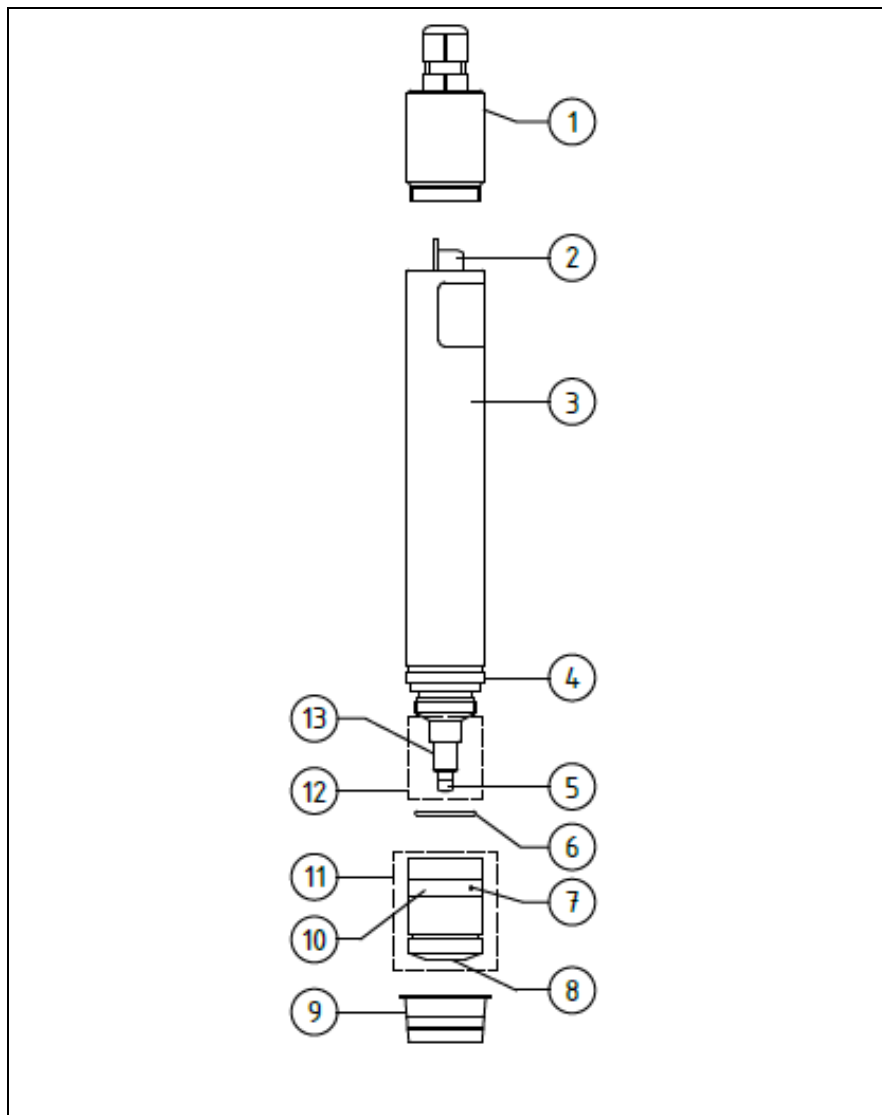

Fig. 1: Product overview

- | | | | |
|---|--------------------------|----|---------------------|
| 1 | mA-hood with cable gland | 8 | Membrane disc |
| 2 | Electrical connection | 9 | Protective cap |
| 3 | Sensor body | 10 | Hose ring |
| 4 | Counter electrode | 11 | Membrane cap |
| 5 | Working electrode | 12 | Electrode finger |
| 6 | O-ring 14 x 1.8 | 13 | Reference electrode |
| 7 | Valve opening | | |

2.4 Name plate

A name plate is glued to each sensor, this shows the following information:

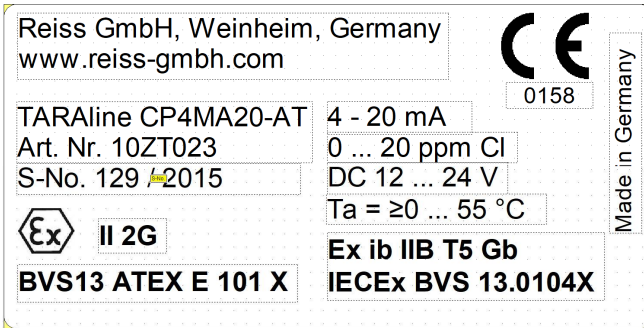

Fig. 2: Example of a name plate

3 Safety

The sensor is manufactured using the latest technology. Nevertheless, improper use can give rise to the following risks:

- Effects on health
- Falsification of measuring values, which can lead to dangerous dosing of incorrect quantities of the disinfectant.
- ▶ Comply with the safety instructions in these operating instructions.

3.1 Use for the intended purpose

The sensor is intended to be used for measuring the concentration of a specific disinfectant in water.

The sensor may be used only under the following conditions:

- For the disinfectant specified in the respective data sheet
- Under the conditions of use specified on the respective data sheet
- Upright installation in a suitable flow chamber
- Restricted to the activities described in these operating instructions.
- Use only when in fault-free condition
- Use of original accessories and spare parts (see <http://www.reiss-gmbh.com/english/datasheets.htm>)

3.2 Use other than for the intended purpose

The sensor may not be used for measurements to demonstrate the absence of the disinfectant.

The sensor may not be put into operation and be operated without complying to the ex-proof specifications (see section 4, p. 15).

3.3 Staff qualifications

The user must hold the following personal qualifications:

- He must have read and understood the operating instructions.
- He must have received training in the handling of the sensor.

3.4 Rebuilding and modifications

Opening the sensor and making modifications to it which can affect the safety and functionality of the sensor may be performed only by the manufacturer.

3.5 Residual risks

3.5.1 Slippage of the sensor

If the sensor is inadequately secured, it may become loose due to the pressure of the water or due to vibration. This results in the following risks:

- Due to the pressure of the water the sensor may slip out of the flow chamber.
- The sensor may slip down into the flow chamber due to its own weight.
 - ▶ Depending on recommendation in the data sheet, use a variant with a retaining ring (see section 1.2, p. 5).
 - ▶ Make sure that the screw fastening cannot come loose during operation.
 - ▶ Check the sensor regularly for secure attachment.

3.5.2 Water pressure that is high or fluctuating

The membrane may be damaged if the water pressure exceeds the maximum permissible value, or if the water pressure fluctuates greatly.

- ▶ Comply with the permissible pressure stated on the data sheet (see section 1.2, p. 5).
- ▶ Keep the pressure constant.

3.5.3 Abrasive particles

Abrasive particles can damage the membrane.

- ▶ Install a filter in the system.

3.5.4 Impacts, shocks and improper touching

Impacts or shaking of the sensor, such as by dropping it, can damage it.

- ▶ Avoid impacts and shocks.
- ▶ Do not allow the sensor to be dropped.

Touching the reference electrode, or using emery paper on it, can damage it.

- ▶ Do not touch the reference electrode.
- ▶ Should it be necessary for maintenance work, only emery the working electrode, **not** the reference electrode.

3.5.5 Defective membrane cap

If when the membrane cap is being screwed on or unscrewed the valve is inadvertently obstructed, this can cause overpressure or underpressure in the membrane cap. This can damage the membrane.

- ▶ When screwing on the membrane cap make sure that the valve is not closed off (see Fig. 7, page 18).
- ▶ Before unscrewing the membrane cap, push the hose ring aside and keep the valve open.

3.5.6 Electrical interference

A lack of galvanic isolation can falsify the measuring value and even damage the sensor beyond repair.

- ▶ Ensure the electrical connection has galvanic isolation.

Electrical interference on the signal lead can damage the electronics.

- ▶ Ensure the connection is made correctly.

3.5.7 Non-compliance with ex-proof specifications

Non-compliance with ex-proof specifications results in a loss of the explosion protection.

- ▶ Comply with ex-proof specifications (see section 4, p. 15)

3.5.8 Lack of disinfectant

If there is insufficient disinfectant in the water for a prolonged period, a film of biological matter can accumulate on the membrane. This makes the measuring value incorrect, and means the membrane cap can no longer be used.

- ▶ Make sure that the period during which there is no disinfectant present is not longer than specified on the data sheet (see section 1.2, p. 5).

3.5.9 Loss of measuring values when the sensor is removed

After the sensor has been removed there is no longer a measuring value, which can lead to incorrect dosing of the disinfectant.

- ▶ Switch off the measurement and control system or switch it over to manual operation.

3.5.10 Oxidants, reducers, corrosion inhibitors and water hardness stabilisers

Oxidants, reducers and corrosion inhibitors in the water interfere with measurement and can lead to measuring errors.

- ▶ Make sure there are no oxidants, reducers, corrosion inhibitors and water hardness stabilisers in the water.
- ▶ Comply with the instructions on the data sheet (see section 1.2, p. 5).

3.5.11 pH value

If the pH value in the water changes or if the pH value lies outside the permissible range the measuring value may be incorrect.

- ▶ Make sure that the pH value lies within the permissible range.
- ▶ Comply with the instructions on the data sheet (see section 1.2, p. 5).

3.5.12 Temperature and fluctuations in temperature

If the ambient temperature or the temperature of the medium lies outside the permissible range, the sensor and the electrolyte may be damaged.

- ▶ Make sure that at all stages of the operation the permissible temperature ranges as per the data sheet are adhered to (see section 1.2, p. 5).

The measuring value may be incorrect if the temperature in the medium fluctuates abruptly.

- ▶ Make sure that the temperature in the water changes only slowly.

3.5.13 Impermissible installation position

If the sensor is not installed upright the measuring value can be falsified.

- ▶ Install the sensor upright.

3.5.14 Incorrect chemical analytical methods

Incorrect determination of the concentration of the disinfectant will lead to incorrect calibration of the sensor.

- ▶ Observe the recommended analysis methods as per the data sheet (see section 1.2, p. 5).
- ▶ Perform analytical work in accordance with the specifications in the manufacturer's operating instructions for the analytical equipment.

4 Ex-proof specifications

The chlorine sensor for the application in an ex-proof area consists of a bar-shaped shaft. At the bottom of the shaft the electrochemical sensor part is located. It consists of electrode finger, stainless steel ring and a membrane cap. Inside the shaft the electronic board is located. Its upper smaller end protrudes from the shaft and is equipped with a 2-pole terminal. The interior of the shaft is filled with a PU sealing compound. The filling level of the sealing compound is designed for covering all electronic parts.

Ex-proof specifications

The electrical connection is carried out by a suitable 2-pole round cable 2 x 0.25 mm² which is lead through the cable gland of the cap and cramped to the 2-pole terminal. The cap is screwed on the shaft and the o-ring 20 x 1.5 seals. After pulling tight the cable gland the electrical connection has got the protection class IP65.

The sensor is only allowed to be connected to a suitable and for the ex-area authorised zener barrier which isn't allowed to go beyond the following parameters:

Parameters	Value
Voltage U_i	25.4 V DC
Current I_i	115 mA
Power P_i	650 mW
Effective internal capacitance C_i	120 nF
Effective internal inductance L_i	13 nH

Tab. 4: *Parameters Zener barrier*

The sensor has the ex-protection class II 2G Ex ib IIB T5 Gb (type of protection intrinsic safety).

Range of environment temperature: $T_a = \geq 0 \dots 55 \text{ }^\circ\text{C}$

Electrical operational characteristics	
Input voltage	12 ... 24 V DC
Current	4 ... 20 mA

Tab. 5: *Electrical operational characteristics*

**SAFETY**

Conditions for safe usage:

1. The sensor shall be mounted in areas where electrostatic charge/discharge will be avoided.
2. Along the external intrinsically safe circuit (between sensor and power supply) must be equipotential equalization.



Ignoring these contents and instructions can result in a loss of the explosion-protection.

5 Commissioning

5.1 Installation requirements

The following installation requirements must be satisfied:

- Continuous power supply and presence of water being measured
- Flow rate as specified on the data sheet
- Constant through flow rate
- There must be disinfectants present in the water being measured.
- Galvanic separation of the electrical connection (if not present in the sensor, see data sheet, section 1.2, p. 5)
- Compliance to ex-proof specifications (see section 4, p. 15)
- Make sure that the measuring water does not evolve gas at the measurement point.

5.2 Preparation of the sensors

- ✓ Requirements according to ex-proof specifications fulfilled (see section 4, p. 15).
- ▶ Pull the protective cap [3] off the membrane cap [2].
- ▶ Unscrew the membrane cap [2] from the sensor body [1].

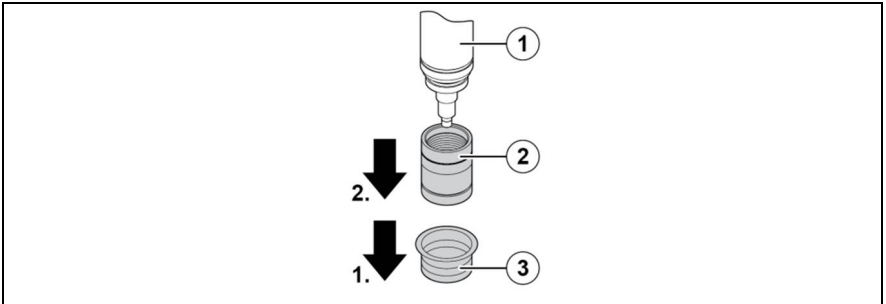

Fig. 3: Unscrew the membrane cap

- 1 Sensor body
- 2 Membrane cap
- 3 Protective cap

- ▶ Put down the membrane cap on a clean surface.
- ▶ Fill the membrane cap with electrolyte to the brim, as free of bubbles as possible.

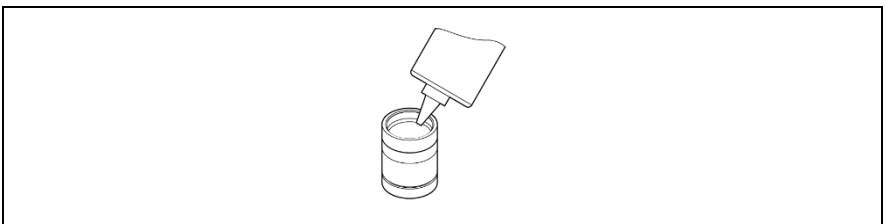

Fig. 4: Fill the membrane cap

- ▶ Place the sensor body [1] upright on the membrane cap [2].
Rotate the sensor body anticlockwise until the thread is felt to engage.

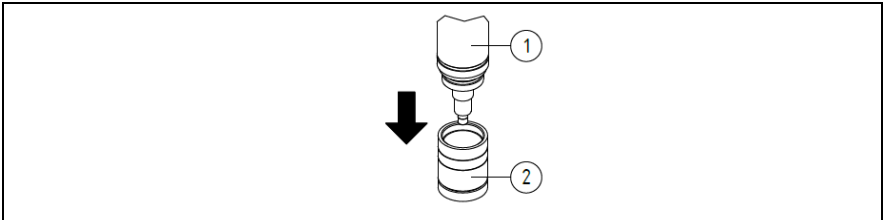

Fig. 5: Place the sensor body on the membrane cap

- 1 Sensor body
- 2 Membrane cap

- ▶ Slowly screw the sensor body into the membrane cap.
- ▶ Make sure that the valve opening is not closed off (e.g. by the fingers).



The first resistance to screwing the parts together comes from the sealing O-ring.

- ▶ Screw the cap on further until it has closed up against the shaft.
- ✓ Once the membrane cap has been fully screwed on:
 - ▶ Do not touch or impact the membrane.
 - ▶ Use mains water to rinse off any electrolyte residues adhering to the sensor.
- ↪ The sensor is now prepared for commissioning.

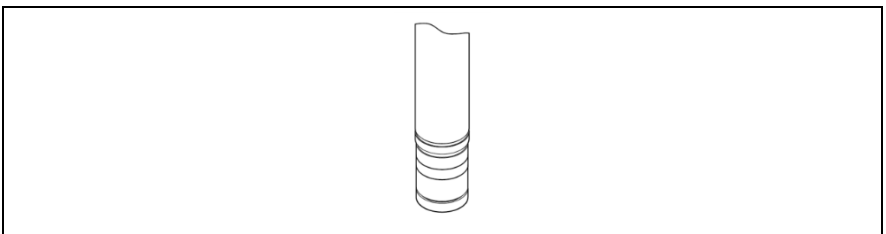

Fig. 6: Prepared sensor

5.3 Insertion into the flow chamber

- ✓ The sensor is prepared (see section 5.2, p. 18).
- ▶ Insert the sensor into a flow chamber of the type TARAflow FLC or any other suitable flow chamber.

In order to insert the sensor correctly into the flow chamber:

- ▶ Comply with the instructions in the operating instructions for the flow chamber that is used.

5.4 Electrical connection

- ✓ The sensor is inserted into the flow chamber (see section 5.3, p. 20).
- ▶ Insert the sensor cable through the cable gland in the hood.
- ▶ Connect the cores to the terminals in the sensor electronics.
- ▶ Screw the hood finger-tight into the sensor body until the O-ring seal is made.
- ▶ Tighten the cable gland so as to secure the cable.
- ▶ Connect the opposite end of the sensor cable to a suitable zener barrier.

5.5 Initial calibration

- ✓ The sensor must have been connected electrically (see section 5.4, p. 20).
- ✓ The run-in time has been complied with as per the data sheet (see section 1.2, p. 5).
- ▶ Perform calibration (see section 6, p. 21).
- ▶ After one day, repeat the calibration.

6 Calibration

The sensor outputs a signal proportional to the concentration of the disinfectant in the water being measured. In order to assign the value of the sensor signal to the concentration of the disinfectant in the water being measured, the sensor must be calibrated.

- ✓ The flow rate must be constant.
- ✓ The temperature of the water being measured must be constant.
- ✓ Acclimatisation of the temperature of the sensor to that of the water being measured must be complete (this takes about 20 minutes after a change in temperature).
- ✓ The sensor must have completed running in.
- ✓ No other oxidant may be present in the water being measured.
- ✓ The pH value must be constant.
- ▶ Take the analytical sample of the water being measured from near to the sensor.
- ▶ Using appropriate methods, determine the concentration of the disinfectant in the measuring water (see the manufacturer's operating instructions for the analytical equipment).
- ▶ In the calibration menu of the measuring and control device, mark up the sensor signal against the value determined by the analytical procedure (see the operating instructions for the device).
- ▶ Repeat the calibration at regular intervals (see section 8.1, p. 22).
- ▶ Comply with the applicable national regulations for calibration intervals.

Measured variables	Recommended analytical methods	
Total chlorine	DPD-1 + DPD-3	Photometer for chlorine
	DPD-4	

Tab. 6: Recommended analytical methods

7 Removal

 Removal of the sensor can lead to an incorrect measuring value at the input to the measuring and control device, which can cause the control circuit to apply uncontrolled dosing.

Before removing the sensor:

- ▶ Observe the ex-proof specifications.
- ▶ Switch off the measurement and control system or switch it over to manual operation.
- ▶ Close the inlet of the water being measured.
- ▶ Close the outlet of the water being measured.
- ▶ Remove the electrical connection.

To disconnect a sensor with a 2-pole screwed terminal block:

- ▶ Undo the cable gland.
- ↪ The cable is now free to move.
- ▶ Unscrew the hood with the cable gland from the sensor.
- ▶ Release the cable cores from the terminals.
- ▶ Undo the screw fastening and carefully pull the sensor out.

8 Maintenance

8.1 Maintenance overview

To ensure optimum performance of the sensor:

- ▶ Perform the following actions at regular intervals.

Maintenance task	Interval
▶ Change the electrolyte	6 months
▶ Change the membrane cap	Annually
▶ Perform calibration	<ul style="list-style-type: none"> • Weekly • After the electrolyte and/or the membrane cap has been changed

Tab. 7: Maintenance overview

8.2 Changing the electrolyte and membrane cap

- ▶ Lift the hose ring [1] sideways off the membrane cap and slide it down.
- The valve opening [2] is now exposed.
- ▶ Unscrew the membrane cap.
- Air can now flow through the valve opening.

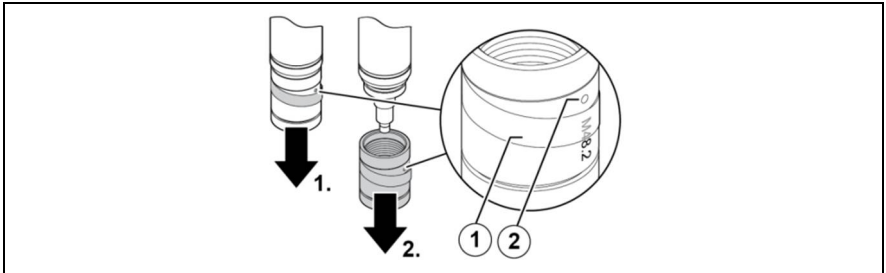

Fig. 7: Lift the hose ring

- 1 Hose ring
- 2 Valve opening

- ▶ Empty the electrolyte out of the membrane cap.
- ▶ Rinse the electrode finger with mains water.
- ▶ Lay a piece of special emery paper on a paper wipe.
- ▶ Hold the sensor upright.
- ▶ Hold the special emery paper in place and move the tip of the working electrode over it at least twice. Use a fresh area of the emery paper for each pass.

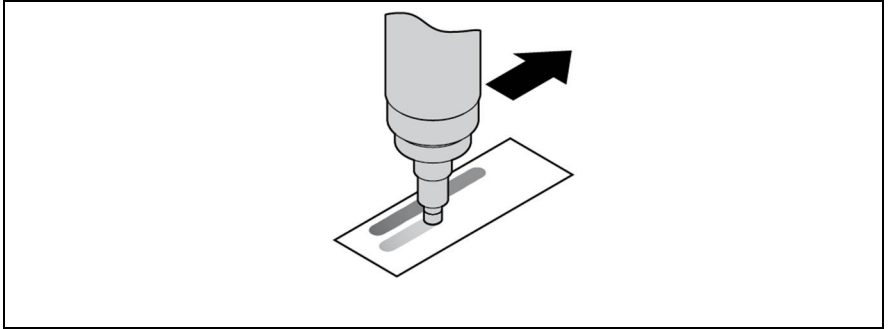

Fig. 8: Emery the working electrode

- ▶ Return the hose ring to its original position.
 - ↪ The valve opening is now covered.
- i** When changing the membrane cap:
- ▶ Use a new membrane cap.
 - ▶ Perform the same operations as for commissioning (see section 5.2, p. 18).
 - ↪ Maintenance has now been completed and the sensor can be put back into use.

9 Troubleshooting

Various factors in the environment can affect the sensor. If irregularities occur, it may be useful to check these factors:

- Flow rate
- Measuring cable
- Measuring and control device
- Zener barrier
- Calibration
- Dosing equipment
- Concentration of the disinfectant in the dosing container
- Suitability of the sensor for measuring the disinfectant that is being dosed
- Concentration of the disinfectant in the water being measured (determined by analytical methods)
- pH value of the water being measured
- Temperature of the water being measured
- Pressure in the flow chamber
- Analytical methods

9.1 Fault overview

Fault	Cause	Corrective action
Sensor cannot be calibrated / deviation of the measuring value from DPD measurement	Gas bubbles in electrolyte	<ul style="list-style-type: none"> ▶ Unscrew membrane cap and empty electrolyte. ▶ Repeat commissioning (see section 5.2, p. 18).
	Run-in time too short.	<ul style="list-style-type: none"> ▶ See section 5.2, p. 18. ▶ Repeat the calibration after a few hours.
	Membrane torn	<ul style="list-style-type: none"> ▶ Change the membrane cap (see section 8.2, p. 23).
	Membrane cap damaged	<ul style="list-style-type: none"> ▶ Change the membrane cap (see section 8.2, p. 23).
	Disruptive substances in the water contents	<ul style="list-style-type: none"> ▶ Check the water for disruptive substances (see data sheet). ▶ Provide remedy. ▶ Consult the supplier.
	Short circuit / defect in the measuring lead	<ul style="list-style-type: none"> ▶ Locate and eliminate the short circuit / defect. ▶ Exchange the measuring lead.
	Distance between working electrode and membrane is too great.	<ul style="list-style-type: none"> ▶ Screw the membrane cap on fully to the stop.

Fault	Cause	Corrective action
	The DPD chemicals are past their effectiveness date.	<ul style="list-style-type: none"> ▶ Use new DPD chemicals. ▶ Repeat the calibration (see section 6, p. 21).
	Deposits on the membrane	<ul style="list-style-type: none"> ▶ Change the membrane cap (see section 8.2, p. 23).
	Gas bubbles on the outside of the membrane	<ul style="list-style-type: none"> ▶ Temporarily increase the flow rate. ▶ Check the installation and modify it.
	No electrolyte in the membrane cap	<ul style="list-style-type: none"> ▶ Fill the membrane cap with electrolyte. ▶ Prepare the sensor (see section 5.2, p. 18).
	The concentration of disinfectant exceeds the upper limit of the measuring range.	<ul style="list-style-type: none"> ▶ Check the system. ▶ Remedy the faults. ▶ Repeat the calibration (see section 6, p. 21).
	Lack of galvanic isolation	<ul style="list-style-type: none"> ▶ Create galvanic isolation. ▶ Return the sensor to the supplier for checking / reconditioning.
	The sensor is defective.	<ul style="list-style-type: none"> ▶ Return the sensor to the supplier for checking / reconditioning.

Troubleshooting

Fault	Cause	Corrective action
Unstable measuring value	Gas bubbles in electrolyte	<ul style="list-style-type: none"> ▶ Unscrew membrane cap and empty electrolyte. ▶ Repeat commissioning (see section 5.2, p. 18).
	Membrane torn	<ul style="list-style-type: none"> ▶ Change the membrane cap (see section 8.2, p. 23).
	Gas bubbles on the outside of the membrane	<ul style="list-style-type: none"> ▶ Temporarily increase the flow rate. ▶ Check the installation and modify it.
	Pressure fluctuations in the measuring water	<ul style="list-style-type: none"> ▶ Check the type of installation and modify it.
	Lack of galvanic isolation	<ul style="list-style-type: none"> ▶ Create galvanic isolation. ▶ Return the sensor to the supplier for checking / reconditioning.
	The reference electrode is exhausted and/or contaminated. ¹	<ul style="list-style-type: none"> ▶ Return the sensor to the supplier for checking / reconditioning.

¹ The reference electrode has a silvery sheen or is white. The usual colour on the other hand is brown/grey.

Fault	Cause	Corrective action
Overdriving ²	Excessive concentration of disinfectant in the measuring water	<ul style="list-style-type: none"> ▶ Check the system. ▶ Remedy the faults. ▶ Calibrate the sensor (see section 6, p. 21). ▶ Perform maintenance on the sensor (see section 8, p. 22).
	Run-in time too short.	▶ Wait until the run-in time has elapsed (see section 5.5, p. 20).
	The membrane is damaged.	▶ Change the membrane cap (see section 8.2, p. 23).
	Flow rate too high	<ul style="list-style-type: none"> ▶ Check the system. ▶ Reduce the flow rate.
	Lack of galvanic isolation	<ul style="list-style-type: none"> ▶ Create galvanic isolation. ▶ Return the sensor to the supplier for checking / reconditioning.
	The sensor is defective.	▶ Return the sensor to the supplier for checking / reconditioning.

² The electronics is receiving an excessively high signal at the input from the electrochemical cell (see Tab. 9, p. 35).

Troubleshooting

Fault	Cause	Corrective action
Underdriving ³	Run-in time too short.	▶ Wait until the run-in time has elapsed (see section 5.5, p. 20).
	The working electrode is contaminated.	▶ Perform maintenance on the sensor (see section 8, p. 22).
	Lack of galvanic isolation	▶ Create galvanic isolation. ▶ Return the sensor to the supplier for checking / reconditioning.
	The sensor is defective.	▶ Return the sensor to the supplier for checking / reconditioning.
No signal	The sensor is connected to the measuring and control device with the wrong polarity.	▶ Connect the sensor correctly to the measuring and control device.
	The measuring lead is broken.	▶ Exchange the measuring lead.
	The sensor is not receiving any power supply.	▶ Provide the correct power supply.
	The sensor is defective.	▶ Return the sensor to the supplier for checking / reconditioning.

³ The electronics is receiving a signal with the wrong polarity at the input from the electrochemical cell (see Tab. 9, p. 35).

Fault	Cause	Corrective action
corrosion/rust on the counter electrode	Lack of galvanic isolation.	▶ Provide galvanic isolation.

Tab. 8: Fault overview

Electronics	Signal transmission	Underdriving	Overdriving
Analogue	4 ... 20 mA	<4 mA	>20 mA

Tab. 9: Output signal of the sensor when overdriven/underdriven

9.2 Special checks

9.2.1 Tightness of the membrane cap

- ▶ Unscrew the membrane cap from the sensor (see section 8, p. 22).
- ▶ Dry the outside of the membrane cap.
- ▶ Prepare the membrane cap (see section 5.2, p. 18).
- ▶ When screwing the membrane cap on, watch out for liquid escaping through the membrane.

 If a drop forms on the outside of the membrane this is not a problem, as the membrane is hydrophilic.

If a flow of drops forms on the membrane:

- ▶ Use a new membrane cap.

If the sensor does not respond:

- ▶ Return the sensor to the supplier for checking.

9.2.2 Electronics

- ▶ Unscrew the membrane cap.
- ▶ Rinse the electrode finger with mains water.
- ▶ Using a clean cloth, carefully dry the electrode finger.
- ▶ Connect the sensor to the measuring and control device.
- ▶ Connect a suitable measuring device to the original sensor signal.
- ▶ Wait five minutes.
- ▶ Read the original sensor signal at the measuring device.
- ▶ Mark up the values that were read against the following target values:
approx. 4 mA

If the sensor signal approximately corresponds to the aforementioned value, the electronics can be provisionally regarded as OK.

If the measured value deviates significantly from the above value:

- ▶ Return the sensor to the supplier for checking.

9.2.3 Checking the zero point

- ✓ The electronics must have been tested and found to be OK.
- ▶ Prepare the sensor (see section 5.2, p. 18).
- ▶ Connect the sensor to the measuring and control device.
- ▶ Fill a glass beaker with mains water (without any disinfectant!).
- ▶ Stir the sensor round in the glass beaker for 30 seconds.
- ▶ Carefully put the sensor down obliquely in the glass beaker.
- ▶ Wait 30 minutes.
- ▶ Read the measuring value.

If the measuring value is close to the value 0, the zero point can provisionally be regarded as OK.

If the measuring value deviates significantly from zero:

- ▶ Perform maintenance on the sensor (see section 8, p. 22) and repeat the zero point test.



A freshly cleaned working electrode has a relatively high zero point. The sensor takes a few days to settle back to its lowest zero point.

If after maintenance has been performed on the sensor measuring value is not close to zero:

- ▶ Return the sensor to the supplier for checking.

- This completes the zero point checking.

9.2.4 Signal

- ✓ The zero point checking must have been performed successfully.
- ▶ Add the relevant disinfectant to the mains water in the glass beaker (see section 9.2.3, p. 32).
- ▶ Stir the sensor steadily round in the glass beaker for five minutes.
- ▶ Monitor the measuring value throughout this time.

If the measuring value increases, the sensor can provisionally be regarded as OK.

If the measuring value does not change:

- ▶ Perform maintenance on the sensor (see section 8, p. 22) and repeat the signal test.

- This completes the signal test. The sensor can be put back into use.

If after maintenance the sensor shows no response to the disinfectant:

- ▶ Return the sensor to the supplier for checking.

10 Technical data

Information on the technical data can be found at the following Internet address:

<http://www.reiss-gmbh.com/english/datasheets.htm>

11 Deinstallation and storage

To deinstall a sensor and prepare it for storage, proceed as follows:

- ▶ Unscrew the membrane cap.
- ▶ Rinse the electrolyte out of the membrane cap with lukewarm tap water every 10 seconds.

 The electrolyte must be completely removed. Otherwise long start-up/contact times may be expected during a recommissioning.

- ▶ Rinse the electrode finger with lukewarm mains water.
- ▶ Dry the membrane cap and sensor body in a dust-free place.
- ▶ For protection, loosely screw the dry membrane cap onto the sensor body.
- ▶ Make sure that the membrane is not lying in contact with the working electrode.

 If the membrane cap has been in use for one day or longer we recommend that it is not used when the sensor is recommissioned.

- ▷ Perform a change of membrane cap (see section 8.2, p. 23).

12 Disposal

- ▶ Comply with the local regulations on disposal.

13 Warranty

We grant a manufacturer's warranty of two years on the sensor body and the electronics, subject to correct handling. This excludes the membrane cap (wearing part), the electrolyte (expendable material) and service work to be carried out (cleaning of the parts coming into contact with the electrolyte, replacement of the reference electrode and cleaning the working electrode with special emery paper). If there is mechanical damage or the serial number is illegible, the warranty becomes void.

Returning a sensor for checking/reconditioning:

Shipments will be accepted only if they are returned carriage paid. Otherwise they will be returned to the sender.

On tested/overhauled sensors there is for expert use a warranty on the sensor body and the electronics of one year from the test-/overhaul date. If there is mechanical damage or the serial number is illegible, this warranty becomes void.

14 Liability disclaimer

The sensor is manufactured with great care and is subjected to a documented function test. Should any malfunctions occur in the sensor despite this, no liability claims may be lodged against the manufacturer for damages resulting from this malfunction.

Reiss GmbH
Electrochemical measuring equipment
Eisleber Str. 5
D - 69469 Weinheim