Operating instructions



TARAline sensors

BR1, CS4, CC1, CP2/CP3/CP4, CN1, MST1

Table of contents

1	Information about these operating instructions.....	4
1.1	Symbols and displays	4
1.2	Associated documents	5
2	Information on this product.....	6
2.1	Product description	6
2.2	Scope of supply	9
2.3	Product overview	10
2.4	Name plate	11
3	Safety	12
3.1	Use for the intended purpose	12
3.2	Use other than for the intended purpose.....	12
3.3	Staff qualifications.....	13
3.4	Rebuilding and modifications.....	13
3.5	Residual risks	13
4	Commissioning.....	16
4.1	Installation requirements	16
4.2	Preparation of the sensors	17
4.3	Insertion into the flow chamber.....	19
4.4	Electrical connection	20
4.5	Initial calibration	22
5	Calibration.....	23
6	Removal	25



7	Maintenance.....	25
7.1	Maintenance overview	25
7.2	Changing the electrolyte and membrane cap.....	26
8	Troubleshooting	27
8.1	Fault overview.....	29
8.2	Special checks.....	37
9	Technical data.....	39
10	Deinstallation and storage	39
11	Disposal	40
12	Warranty.....	40
13	Liability disclaimer.....	40
14	Appendix.....	41
14.1	Chlorite analysis methods	41

1 Information about these operating instructions

1.1 Symbols and displays







1.1.1 Safety and warning instructions

The hazard symbols and signal words listed below are used in these operating instructions. They help you use the product safely, protect the operating personnel against injuries and protect the operating company against damage to property and additional costs.

	Signal word	Meaning
	DANGER!	DANGER means a hazard with a high degree of risk which if not avoided will lead to death or serious injury.
	WARNING!	WARNING means a hazard with a medium degree of risk which if not avoided may lead to death or serious injury.
	CAUTION!	CAUTION means a hazard with a low degree of risk which if not avoided may lead to minor or moderate injury.
	NOTE	NOTE warns against damage to property.

Tab. 1: Signal words

1.1.2 Labels in the text

Symbol	Meaning
	This symbol is the general warning symbol and warns you about risks of injury. Take all the actions that are indicated by this warning symbol.
	This symbol indicates tips and helpful information for optimum and economic use of the product.
	This symbol indicates actions to be performed by the personnel.
	This symbol indicates the result of an action.
	This symbol indicates individual bullet points.
	This symbol indicates a precondition before performing an action.

Tab. 2: *Labels in the text*

1.2 Associated documents

Data sheets on the individual types of sensors can be found at the following Internet address:

<https://www.reiss-gmbh.com/english/datasheets.htm>

2 Information on this product

2.1 Product description

The sensors in the TARAline product range are 3-electrode systems with covering membranes for measuring the disinfectants chlorine¹, bromine or chloride dissolved in water. The area of application of these sensors comprises swimming baths or water with qualities similar to those of drinking water.

The sensors are not suitable for checking for the absence of chlorine², bromine or chloride.

A complete measuring and/or control system normally consists of the following components:

- Sensor
- Electrical leads and connectors
- Flow chambers and connections
- Measuring and control device
- Dosing equipment
- Analytical equipment



These operating instructions relate exclusively to the sensor.

- ▷ Comply with the operating instructions for the peripheral devices.

¹ Free chlorine, total chlorine or (iso)cyanuric acid-based chlorine

² Apart from TARAline CN1 zero-chlorine sensor

2.1.1 Free chlorine CS4

The sensor measures the concentration of free chlorine in the water being measured, resulting from the application of inorganic chlorine products (such as chlorine gas, sodium hypochlorite solution, calcium hypochlorite solution).

The sensor has a reduced pH dependency.

2.1.2 (Iso)cyanuric acid-based chlorine CC1

The sensor measures the concentration of free chlorine in the water being measured in the presence of (iso)cyanuric acid.

The sensor has a greatly reduced pH dependency.

2.1.3 Total chlorine CP2/CP3/CP4

The sensor measures the concentration of total chlorine in the water being measured, resulting from the application of inorganic chlorine products (such as chlorine gas, sodium hypochlorite solution, calcium hypochlorite solution).

The following types of chlorine are recorded:

- “Free chlorine” made up of inorganic chlorination products (chlorine gas, hypochlorite, etc.)
- “Bonded chlorine”, chloramine.

The sensor has a greatly reduced pH dependency.

2.1.4 Zero-chlorine CN1 (free chlorine)

The sensor measures the concentration of free chlorine in the water being measured, resulting from the application of inorganic chlorine products (such as chlorine gas, sodium hypochlorite solution, calcium hypochlorite solution).

The zero-chlorine sensor can be used in applications in which the absence of chlorine needs to be temporarily monitored.

2.1.5 Bromine BR1

The sensor measures the concentration of bromine in the water being measured resulting from the application of hypobromous acid (HOBr), bromochlorodimethylhydantoin (BCDMH) or liquid stabilized bromine (stabiliser sulphamate).

The sensor has a greatly reduced pH dependency.

2.1.6 Chlorite MST1

The sensor measures the concentration of chlorite in the water being measured, resulting from the application of chlorine dioxide (created for example by the acid/chlorite process, chlorine/chlorite process).

The sensor is usable in water of drinking quality.

2.2 Scope of supply

- ▶ Keep the all the packaging for the sensor.
- ▶ In the event of repair or warranty please return the sensor in the original packaging.
- ▶ Check that the delivery is complete and undamaged.

If it is damaged:

- ▶ Please contact your supplier.

Component	Quantity	Sensor with voltage output signal (0...+/-2000 mV)	Sensor with 4...20-mA-current loop output signal		Sensor with Modbus signal transmission
			(2-pole screw terminal connection)	(5-pole M12-connection)	
Sensor with membrane cap (depending on type) ³	1	✓	✓	✓	✓
Electrolyte (depending on type)	1 bottle	✓	✓	✓	✓
mA hood with O-ring, 20 x 1.5	1	–	✓	–	–
Special emery paper (depending on type)	1	✓	✓	✓	✓
Operating instructions	1	✓	✓	✓	✓

Tab. 3: Scope of supply

³ For TARAline CN1 only: Membrane cap with G-holder

2.3 Product overview

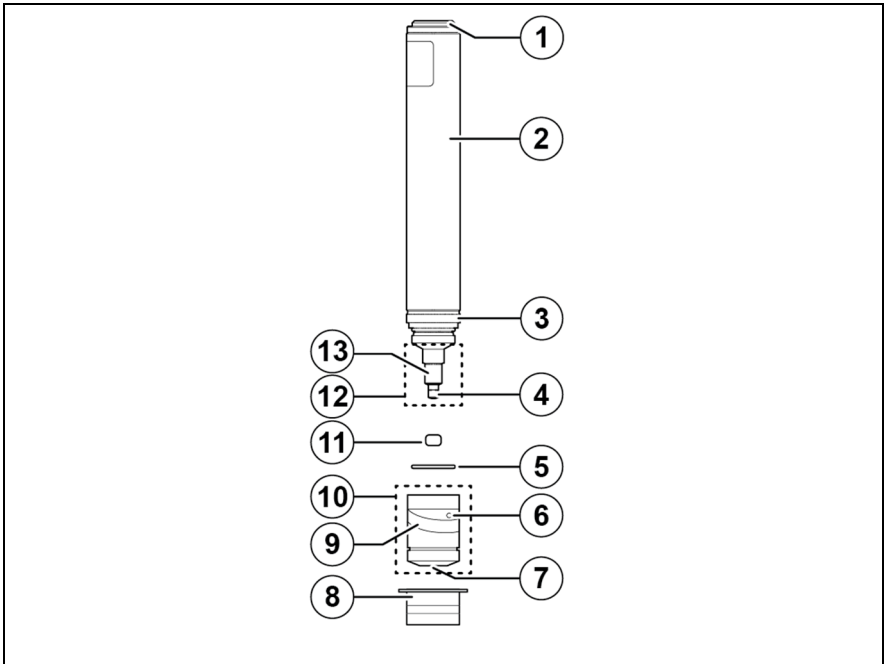

Fig. 1: Product overview

- | | | | |
|---|-----------------------|----|-----------------------|
| 1 | Electrical connection | 8 | Protective cap |
| 2 | Sensor body | 9 | Hose ring |
| 3 | Counter electrode | 10 | Membrane cap |
| 4 | Working electrode | 11 | G-holder ⁴ |
| 5 | O-ring 14 x 1.8 | 12 | Electrode finger |
| 6 | Valve opening | 13 | Reference electrode |
| 7 | Membrane disc | | |

⁴ With TARALine CN1 only

2.4 Name plate

A name plate is glued to each sensor, this shows the following information:

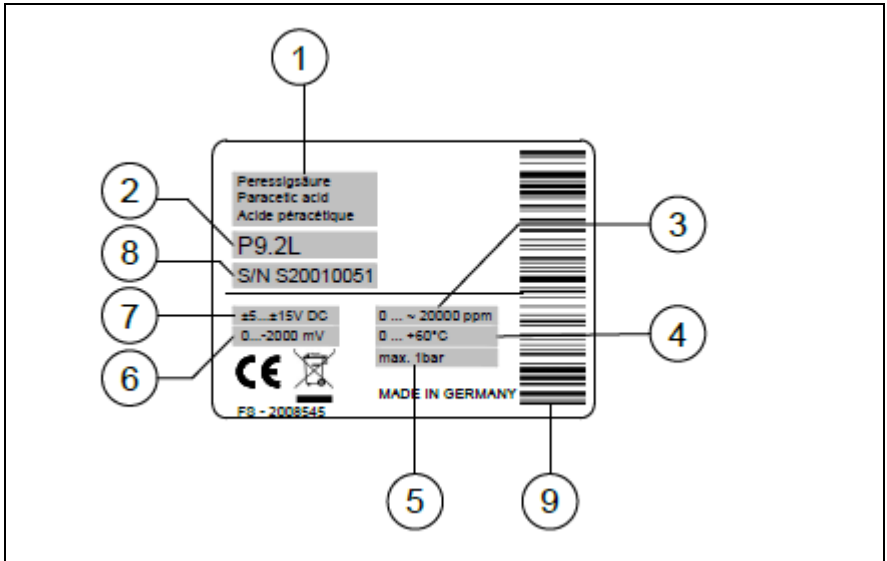

Fig. 2: Example of a name plate

- 1 Measured variables
- 2 Sensor designation, sensor name
- 3 Nominal measuring range of the sensor
- 4 Permissible temperature range of the measuring water
- 5 Maximum permissible pressure of the water being measured
- 6 Signal transmission
- 7 Power supply
- 8 Serial number
- 9 Serial number as barcode

3 Safety

The sensor is manufactured using the latest technology.

Nevertheless, improper use can give rise to the following risks:

- Effects on health
- Falsification of measuring values, which can lead to dangerous dosing of incorrect quantities of the disinfectant.
- ▶ Comply with the safety instructions in these operating instructions.

3.1 Use for the intended purpose

The sensor is intended to be used for measuring the concentration of a specific disinfectant in water.

The sensor may be used only under the following conditions:

- For the disinfectant specified in the respective data sheet
- Under the conditions of use specified on the respective data sheet
- Upright installation in a suitable flow chamber (electrical connection top)
- Restricted to the activities described in these operating instructions.
- Use only when in fault-free condition
- Use of original accessories and spare parts (see <https://www.reiss-gmbh.com/english/datasheets.htm>)

3.2 Use other than for the intended purpose

The sensor may not be used for measurements to demonstrate the absence of the disinfectant⁵.

The sensor must not be used for applications beyond the intended purpose (see section 3.1, p. 12).

⁵ Apart from TARAline CN1 (see data sheet)

3.3 Staff qualifications

The user must hold the following personal qualifications:

- He must have read and understood the operating instructions.
- He must have received training in the handling of the sensor.

3.4 Rebuilding and modifications

Opening the sensor and making modifications to it which can affect the safety and functionality of the sensor may be performed only by the manufacturer.

3.5 Residual risks

3.5.1 Slippage of the sensor

If the sensor is inadequately secured, it may become loose due to the pressure of the water or due to vibration. This results in the following risks:

- Due to the pressure of the water the sensor may slip out of the flow chamber.
- The sensor may slip down into the flow chamber due to its own weight.
 - ▶ Depending on recommendation in the data sheet, use a variant with a retaining ring (see section 1.2, p. 5).
 - ▶ Make sure that the fixation of the sensor in the flow chamber cannot be loosened during operation.
 - ▶ Check the sensor regularly for secure attachment.

3.5.2 Water pressure that is high or fluctuating

The membrane may be damaged if the water pressure exceeds the maximum permissible value, or if the water pressure fluctuates greatly.

- ▶ Comply with the permissible pressure stated on the data sheet (see section 1.2, p. 5).
- ▶ Keep the pressure constant.

3.5.3 Abrasive particles

Abrasive particles can damage the membrane.

- ▶ Install a filter in the system.

3.5.4 Impacts, shocks and improper touching

Impacts or shaking of the sensor, such as by dropping it, can damage it.

- ▶ Avoid impacts and shocks.
- ▶ Do not allow the sensor to be dropped.



Do not touch the sensor electrodes at any time.

Touching the reference electrode, or using emery paper on it, can damage it.

- ▶ Do not touch the reference electrode.
- ▶ Should it be necessary for maintenance work, only emery the working electrode, **not** the reference electrode.

3.5.5 Defective membrane cap

If when the membrane cap is being screwed on or unscrewed the valve is inadvertently obstructed, this can cause overpressure or underpressure in the membrane cap. This can damage the membrane.

- ▶ When screwing on the membrane cap make sure that the valve is not closed off (see Fig. 7, page 18).
- ▶ Before unscrewing the membrane cap, push the hose ring aside and keep the valve open.

3.5.6 Electrical interference

A lack of galvanic isolation can falsify the measuring value and even damage the sensor beyond repair.

- ▶ Ensure the electrical connection has galvanic isolation.

Electrical interference on the signal lead can damage the electronics.

- ▶ Ensure the connection is made correctly (see section 4.4, p. 20).

3.5.7 Lack of disinfectant

If there is insufficient disinfectant in the water for a prolonged period, a film of biological matter can accumulate on the membrane. This makes the measuring value incorrect, and means the membrane cap can no longer be used.

- ▶ Make sure that the period during which there is no disinfectant present is not longer than specified on the data sheet (see section 1.2, p. 5).

3.5.8 Loss of measuring values when the sensor is removed

After the sensor has been removed there is no longer a measuring value, which can lead to incorrect dosing of the disinfectant.

- ▶ Switch off the measurement and control system or switch it over to manual operation.

3.5.9 Oxidants, reducers, corrosion inhibitors and water hardness stabilisers

Oxidants, reducers and corrosion inhibitors in the water interfere with measurement and can lead to measuring errors.

- ▶ Make sure there are no oxidants, reducers, corrosion inhibitors and water hardness stabilisers in the water.
- ▶ Comply with the instructions on the data sheet (see section 1.2, p. 5).

3.5.10 pH value

If the pH value in the water changes or if the pH value lies outside the permissible range the measuring value may be incorrect.

- ▶ Make sure that the pH value lies within the permissible range.
- ▶ Comply with the instructions on the data sheet (see section 1.2, p. 5).

3.5.11 Temperature and fluctuations in temperature

If the ambient temperature or the temperature of the medium lies outside the permissible range, the sensor and the electrolyte may be damaged.

- ▶ Make sure that at all stages of the operation the permissible temperature ranges as per the data sheet are adhered to (see section 1.2, p. 5).

The measuring value may be incorrect if the temperature in the medium fluctuates abruptly.

- ▶ Make sure that the temperature in the water changes only slowly.

3.5.12 Impermissible installation position

If the sensor is not installed upright the measuring value can be falsified.

- ▶ Install the sensor upright (electrical connection top).

3.5.13 Incorrect chemical analytical methods

Incorrect determination of the concentration of the disinfectant will lead to incorrect calibration of the sensor.

- ▶ Observe the recommended analysis methods as per the data sheet (see section 1.2, p. 5).
- ▶ Perform analytical work in accordance with the specifications in the manufacturer's operating instructions for the analytical equipment.

4 Commissioning

4.1 Installation requirements

The following installation requirements must be satisfied:

- Continuous power supply and presence of water being measured
- Flow rate as specified on the data sheet
- Constant through flow rate
- There must be disinfectants present in the water being measured.
- Galvanic separation of the electrical connection (if not present in the sensor, see data sheet, section 1.2, p. 5)
- Make sure that the measuring water does not evolve gas at the measurement point.

4.2 Preparation of the sensors

- ▶ Pull the protective cap [3] off the membrane cap [2].
- ▶ Unscrew the membrane cap [2] from the sensor body [1].

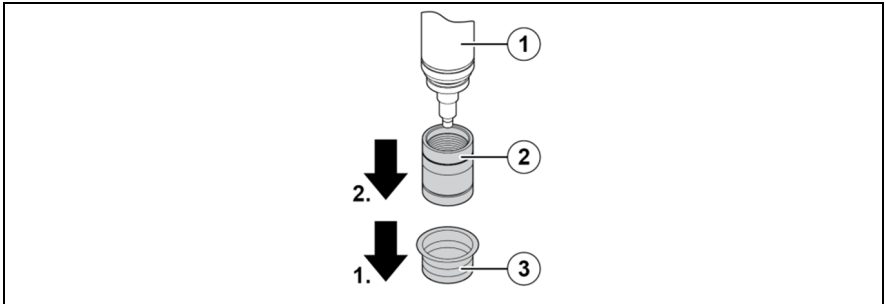

Fig. 3: Unscrew the membrane cap

- 1 Sensor body
- 2 Membrane cap
- 3 Protective cap

- ▶ Put down the membrane cap on a clean surface.
- ▶ Fill the membrane cap with electrolyte to the brim, as free of bubbles as possible.

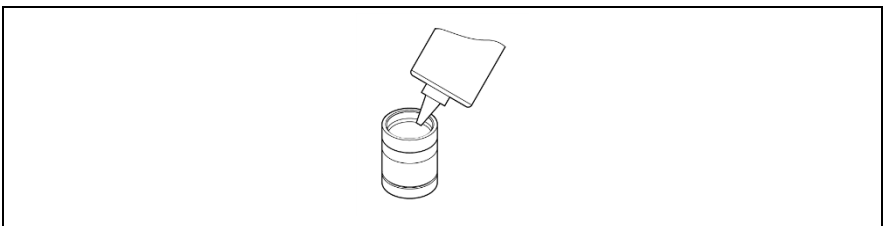

Fig. 4: Fill the membrane cap

- ▶ Place the G-holder⁶ on a clean surface.
- ▶ Fill the G-holder with electrolyte.

⁶ Only supplied with TARAline CN1 sensor.

Commissioning

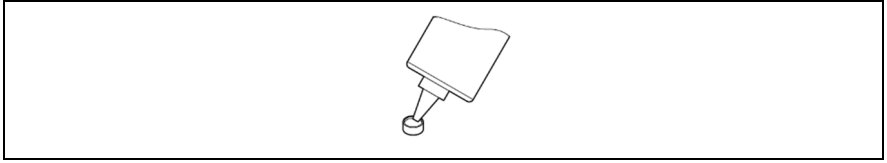

Fig. 5: Fill the G-holder

- ▶ Hold sensor body [1] upright and carefully push the electrode finger into the filled G-holder [2].

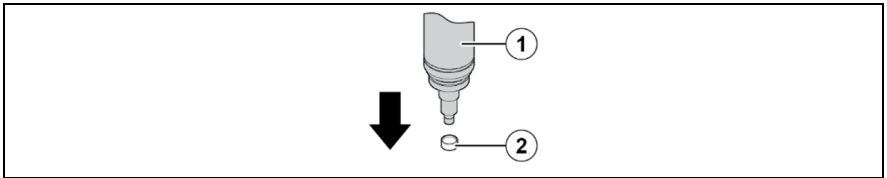

Fig. 6: Press sensor body into the G-holder

- 1 Sensor body
- 2 G-holder

- ▶ Place the sensor body [1] upright on the membrane cap [2]. Rotate the sensor body anticlockwise until the thread is felt to engage.

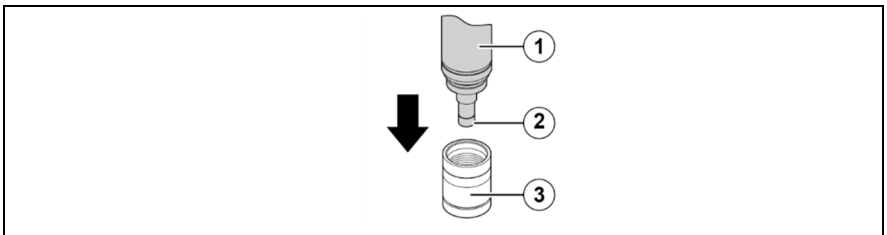

Fig. 7: Place the sensor body on the membrane cap

- 1 Sensor body
- 2 G-holder
- 3 Membrane cap

- ▶ Slowly screw the sensor body into the membrane cap.
- ▶ Make sure that the valve opening is not closed off (e.g. by the fingers).



The first resistance to screwing the parts together comes from the sealing O-ring.

- ▶ Screw the cap on further until it has closed up against the shaft.
- ✓ Once the membrane cap has been fully screwed on:
 - ▶ Do not touch or impact the membrane.
 - ▶ Use mains water to rinse off any electrolyte residues adhering to the sensor.
- ↪ The sensor is now prepared for commissioning.

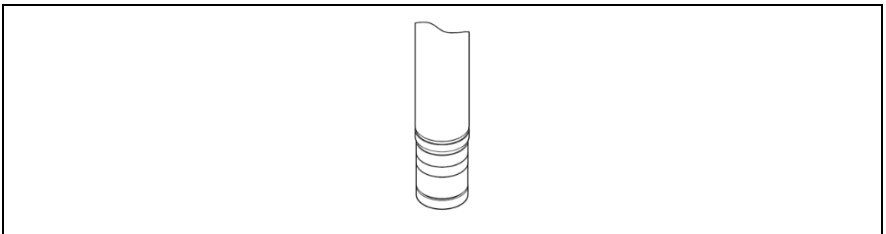

Fig. 8: Prepared sensor

4.3 Insertion into the flow chamber

- ✓ The sensor is prepared (see section 4.2, p. 17).
- ▶ Insert the sensor into a flow chamber of the type TARAflow FLC or any other suitable flow chamber.

In order to insert the sensor correctly into the flow chamber:

- ▶ Comply with the instructions in the operating instructions for the flow chamber that is used.

4.4 Electrical connection

✓ The sensor is inserted into the flow chamber (see section 4.3, p. 19). The following types of electrical connections to the sensor are available:

4.4.1 Connection with 0...+/-2000-mV signal output

The sensor is provided with a 5-pin M12 screwed plug protected against polarity reversal. The connection pins are assigned as follows:

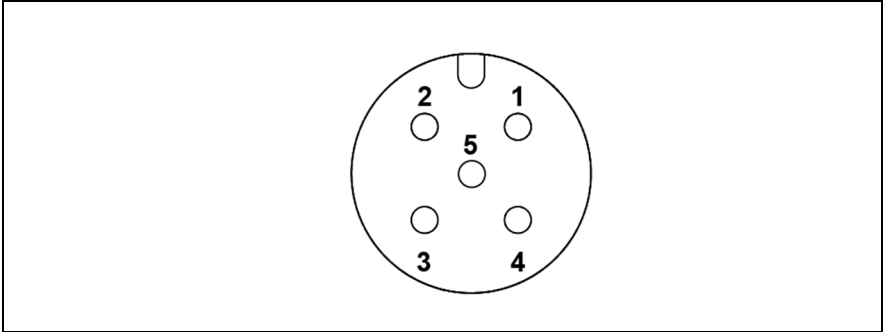

Fig. 9: Pin assignment (5-pin)

	Analog signal processing		Digital signal processing
	0...-2000 mV	0...+2000 mV	0...+/-2000 mV
1	Measuring signal	Measuring signal	Measuring signal
2	+U	+U	+U
3	-U	Power GND	Power GND
4	Signal GND	Signal GND	Signal GND
5	(not assigned)	(not assigned)	(not assigned)

4.4.2 Connection with 4...20 mA signal output

M12 screwed plug

The sensor is provided with a 5-pin M12 screwed plug protected against polarity reversal.

The connection pins are assigned as follows:

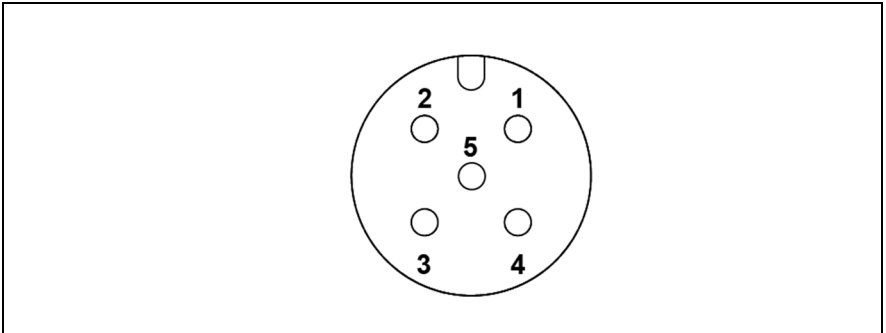

Fig. 10: Pin assignment (5-pin)

- 1 (not assigned)
- 2 +U
- 3 -U
- 4 (not assigned)
- 5 (not assigned)

Connection with a 2-pole screwed terminal block

The sensor is provided with a 2-pole screwed terminal block.

- ▶ Insert the sensor cable through the cable gland in the hood.
- ▶ Connect the cores to the terminals in the sensor electronics.
- ▶ Screw the hood finger-tight into the sensor body until the O-ring seal is made.
- ▶ Tighten the cable gland so as to secure the cable.

4.4.3 Connection with Modbus signal transmission

The sensor is provided with a 5-pin M12 screwed plug protected against polarity reversal. There are no termination resistors within the sensor. The connection pins are assigned as follows:

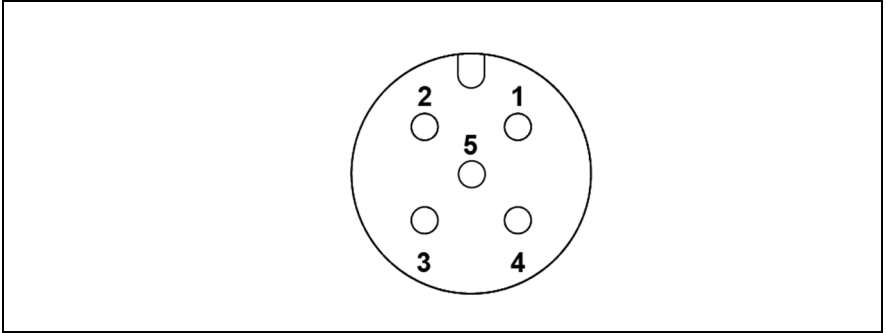

Fig. 11: Pin assignment (5-pin)

- 1 (reserved)
- 2 +9...+30 V
- 3 Power GND
- 4 RS485 B
- 5 RS485 A

4.5 Initial calibration

- ✓ The sensor must have been connected electrically (see section 4.4, p. 20).
- ✓ The run-in time has been complied with as per the data sheet (see section 1.2, p. 5).
 - ▶ Perform calibration (see section 5, p. 23).
 - ▶ After one day, repeat the calibration.

5 Calibration

The sensor outputs a signal proportional to the concentration of the disinfectant in the water being measured. In order to assign the value of the sensor signal to the concentration of the disinfectant in the water being measured, the sensor must be calibrated.

- ✓ The flow rate must be constant.
- ✓ The temperature of the water being measured must be constant.
- ✓ Acclimatisation of the temperature of the sensor to that of the water being measured must be complete (this takes about 20 minutes after a change in temperature).
- ✓ The sensor must have completed running in.
- ✓ No other oxidant may be present in the water being measured.
- ✓ The pH value must be constant.
- ▶ Take the analytical sample of the water being measured from near to the sensor.
- ▶ Using appropriate methods, determine the concentration of the disinfectant in the measuring water (see the manufacturer's operating instructions for the analytical equipment).
- ▶ In the calibration menu of the measuring and control device, mark up the sensor signal against the value determined by the analytical procedure (see the operating instructions for the device).
- ▶ Repeat the calibration at regular intervals (see section 7.1, p. 25).
- ▶ Comply with the applicable national regulations for calibration intervals.

Calibration

Measured variables	Recommended analytical methods	
Free chlorine	DPD-1	Up to 10 ppm: Photometer for chlorine
	Iodometry	Up to 200 ppm: Photometer for chlorine
Free chlorine with (iso)cyanuric acid	DPD-1	Photometer for chlorine
Total chlorine	DPD-1 + DPD-3	Photometer for chlorine
	DPD-4	
Chlorite	Chlorite analysis methods (for technical manual see appendix)	
Free bromine	DPD-1	Photometer for bromine
Bromine made up of BCDMH	DPD-4	Photometer for bromine
Liquid stabilized bromine (stabiliser sulphamate)		

Tab. 4: Recommended analytical methods



Bromine can also be determined using a photometer intended for chlorine. The result must be multiplied by a factor of 2.25.

At higher concentrations of disinfectant the DPD colouration may fail to appear.

6 Removal

 Removal of the sensor can lead to an incorrect measuring value at the input to the measuring and control device, which can cause the control circuit to apply uncontrolled dosing.

Before removing the sensor:

- ▶ Switch off the measurement and control system or switch it over to manual operation.
- ▶ Close the inlet of the water being measured.
- ▶ Close the outlet of the water being measured.
- ▶ Remove the electrical connection.

To disconnect a sensor with a 2-pole screwed terminal block:

- ▶ Undo the cable gland.
- ↪ The cable is now free to move.
- ▶ Unscrew the hood with the cable gland from the sensor.
- ▶ Release the cable cores from the terminals.
- ▶ Undo the screw fastening and carefully pull the sensor out.

7 Maintenance

7.1 Maintenance overview

To ensure optimum performance of the sensor:

- ▶ Perform the following actions at regular intervals.

Maintenance task	Interval
▶ Change the electrolyte	<ul style="list-style-type: none"> • BR1, CC1, CN1, CP2/CP3, MST1: 3-6 months • CS4, CP4: 12 months
▶ Change the membrane cap	Annually
▶ Perform calibration	<ul style="list-style-type: none"> • Weekly • After the electrolyte and/or the membrane cap has been changed

Tab. 5: Maintenance overview

7.2 Changing the electrolyte and membrane cap

- ▶ Lift the hose ring [1] sideways off the membrane cap and slide it down.
- ➔ The valve opening [2] is now exposed.
- ▶ Unscrew the membrane cap.
- ➔ Air can now flow through the valve opening.



For TARAline CN1 only:

The G-holder generally remains in position in the membrane cap and can be left there during the change of electrolyte.

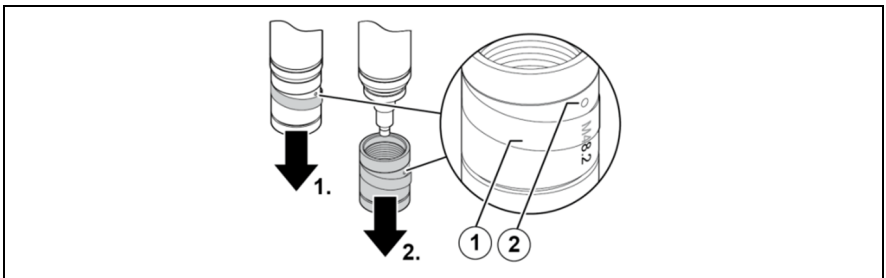

Fig. 12: Lift the hose ring

- 1 Hose ring
- 2 Valve opening

- ▶ Empty the electrolyte out of the membrane cap.
- ▶ Rinse the membrane cap with mains water.
- ▶ Rinse the electrode finger with mains water.
- ▶ Lay a piece of special emery paper on a paper wipe.
- ▶ Hold the sensor upright.
- ▶ Hold the special emery paper in place and move the tip of the working electrode over it at least twice. Use a fresh area of the emery paper for each pass.

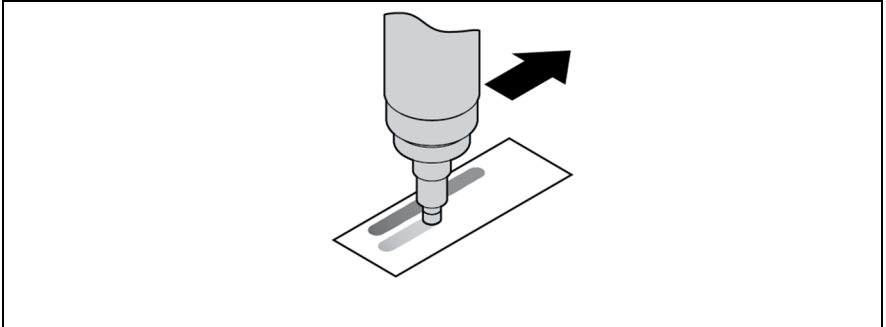

Fig. 13: Emery the working electrode

- ▶ Return the hose ring to its original position.
- ↪ The valve opening is now covered.



When changing the membrane cap:

- ▶ Use a new membrane cap.
- ▶ Perform the same operations as for commissioning (see section 4.2, p. 17).
- ↪ Maintenance has now been completed and the sensor can be put back into use.

8 Troubleshooting

Various factors in the environment can affect the sensor. If irregularities occur, it may be useful to check these factors:

- Flow rate
- Measuring cable
- Measuring and control device
- Calibration
- Dosing equipment
- Concentration of the disinfectant in the dosing container
- Suitability of the sensor for measuring the disinfectant that is being dosed

Troubleshooting

- Concentration of the disinfectant in the water being measured (determined by analytical methods)
- pH value of the water being measured
- Temperature of the water being measured
- Pressure in the flow chamber
- Analytical methods

8.1 Fault overview

Fault	Cause	Corrective action
Sensor cannot be calibrated / deviation of the measuring value from DPD measurement	For TARAline CN1 only: Air pockets between G-holder ⁷ /membrane/working electrode	<ul style="list-style-type: none"> ▶ Unscrew membrane cap and empty electrolyte. ▶ Remove G-holder from membrane cap (forceps) and rinse with tap water. ▶ Repeat commissioning (see section 4.2, p. 17).
	Only for TARAline CP2.1HUn, CP2.1H: Pressure compensation membrane leaking/destroyed.	<ul style="list-style-type: none"> ▶ Change the membrane cap (see section 7.2, p. 26).
	Gas bubbles in electrolyte	<ul style="list-style-type: none"> ▶ Unscrew membrane cap and empty electrolyte. ▶ Repeat commissioning (see section 4.2, p. 17).
	Run-in time too short.	<ul style="list-style-type: none"> ▶ Wait for run-in period (see section 4.5, p. 22). ▶ Repeat the calibration after a few hours.

⁷ Only supplied with TARAline CN1 sensor.

Troubleshooting

Fault	Cause	Corrective action
	Membrane torn	<ul style="list-style-type: none"> ▶ Change the membrane cap (see section 7.2, p. 26).
	Membrane cap damaged	<ul style="list-style-type: none"> ▶ Change the membrane cap (see section 7.2, p. 26).
	Disruptive substances in the water contents	<ul style="list-style-type: none"> ▶ Check the water for disruptive substances (see data sheet). ▶ Provide remedy. ▶ Consult the supplier.
	Short circuit / defect in the measuring lead	<ul style="list-style-type: none"> ▶ Locate and eliminate the short circuit / defect. ▶ Exchange the measuring lead.
	Distance between working electrode and membrane is too great.	<ul style="list-style-type: none"> ▶ Screw the membrane cap on fully to the stop.
	The DPD chemicals are past their effectiveness date.	<ul style="list-style-type: none"> ▶ Use new DPD chemicals. ▶ Repeat the calibration (see section 5, p. 23).
	Deposits on the membrane	<ul style="list-style-type: none"> ▶ Change the membrane cap (see section 7.2, p. 26).
	Gas bubbles on the outside of the membrane	<ul style="list-style-type: none"> ▶ Temporarily increase the flow rate. ▶ Check the installation and modify it.

Fault	Cause	Corrective action
	No electrolyte in the membrane cap	<ul style="list-style-type: none"> ▶ Fill the membrane cap with electrolyte. ▶ Prepare the sensor (see section 4.2, p. 17).
	The concentration of disinfectant exceeds the upper limit of the measuring range.	<ul style="list-style-type: none"> ▶ Check the system. ▶ Remedy the faults. ▶ Repeat the calibration (see section 5, p. 23).
	Lack of galvanic isolation	<ul style="list-style-type: none"> ▶ Create galvanic isolation. ▶ Return the sensor to the supplier for checking / reconditioning.
	The sensor is defective.	<ul style="list-style-type: none"> ▶ Return the sensor to the supplier for checking / reconditioning.
Unstable measuring value	For TARAline CN1 only: Air pockets between G-holder/membrane/working electrode	<ul style="list-style-type: none"> ▶ Unscrew the membrane cap. ▶ Remove G-holder from membrane cap (forceps) and rinse with tap water. ▶ Repeat commissioning (see section 4.2, p. 17).

Troubleshooting

Fault	Cause	Corrective action
	Only for TARALine CP2.1HUn, CP2.1H: Pressure compensation membrane leaking/destroyed	<ul style="list-style-type: none"> ▶ Unscrew the membrane cap. ▶ Repeat commissioning (see section 4.2, p. 17).
	Gas bubbles in electrolyte	<ul style="list-style-type: none"> ▶ Unscrew membrane cap and empty electrolyte. ▶ Repeat commissioning (see section 4.2, p. 17).
	Membrane torn	<ul style="list-style-type: none"> ▶ Change the membrane cap (see section 7.2, p. 26).
	Gas bubbles on the outside of the membrane	<ul style="list-style-type: none"> ▶ Temporarily increase the flow rate. ▶ Check the installation and modify it.
	Pressure fluctuations in the measuring water	<ul style="list-style-type: none"> ▶ Check the type of installation and modify it.
	Lack of galvanic isolation	<ul style="list-style-type: none"> ▶ Create galvanic isolation. ▶ Return the sensor to the supplier for checking / reconditioning.

Fault	Cause	Corrective action
	The reference electrode is exhausted and/or contaminated. ⁸	<ul style="list-style-type: none"> ▶ Return the sensor to the supplier for checking / reconditioning.
Overdriving ⁹	Excessive concentration of disinfectant in the measuring water	<ul style="list-style-type: none"> ▶ Check the system. ▶ Remedy the faults. ▶ Calibrate the sensor (see section 5, p. 23). ▶ Perform maintenance on the sensor (see section 7, p. 25).
	Run-in time too short.	<ul style="list-style-type: none"> ▶ Wait until the run-in time has elapsed (see section 4.5, p. 22).
	The membrane is damaged.	<ul style="list-style-type: none"> ▶ Change the membrane cap (see section 7.2, p. 26).
	Flow rate too high	<ul style="list-style-type: none"> ▶ Check the system. ▶ Reduce the flow rate.
	Lack of galvanic isolation	<ul style="list-style-type: none"> ▶ Create galvanic isolation. ▶ Return the sensor to the supplier for checking / reconditioning.

⁸ The reference electrode has a silvery sheen or is white. The usual colour on the other hand is brown/grey.

⁹ see Tab. 7, p. 35.

Troubleshooting

Fault	Cause	Corrective action
	The sensor is defective.	<ul style="list-style-type: none"> ▶ Return the sensor to the supplier for checking / reconditioning.
Underdriving ¹⁰	Run-in time too short.	<ul style="list-style-type: none"> ▶ Wait until the run-in time has elapsed (see section 4.5, p. 22).
	The working electrode is contaminated.	<ul style="list-style-type: none"> ▶ Perform maintenance on the sensor (see section 7, p. 25).
	Lack of galvanic isolation	<ul style="list-style-type: none"> ▶ Create galvanic isolation. ▶ Return the sensor to the supplier for checking / reconditioning.
	The sensor is defective.	<ul style="list-style-type: none"> ▶ Return the sensor to the supplier for checking / reconditioning.
Green LED flickering or failing to light up ¹¹	Defective Power supply	<ul style="list-style-type: none"> ▶ Provide the correct power supply.
	The sensor is defective.	<ul style="list-style-type: none"> ▶ Return the sensor to the supplier for checking / reconditioning.

¹⁰ see Tab. 7, p. 35.

¹¹ Only for sensors with digital electronics

Fault	Cause	Corrective action
No signal	The sensor is connected to the measuring and control device with the wrong polarity. ¹²	▶ Connect the sensor correctly to the measuring and control device.
	The measuring lead is broken.	▶ Exchange the measuring lead.
	The sensor is not receiving any power supply.	▶ Provide the correct power supply.
	The sensor is defective.	▶ Return the sensor to the supplier for checking / reconditioning.
corrosion/rust on the counter electrode	Lack of galvanic isolation.	▶ Provide galvanic isolation.

Tab. 6: Fault overview

¹² Only for sensors with 4...20-mA signal output

Troubleshooting

Electronics	Signal transmission	Underdriving	Overdriving
Analogue	4 ... 20 mA	<4 mA	>20 mA
	0 ... +2000 mV	<0 mV	>+2000 mV
	0 ... -2000 mV	>0 mV	<-2000 mV
Digital	Modbus RTU	<0 ppm/ % <0 nA	Measured value > Measurement range
	0 ... +2000 mV	Orange LED lights up ¹³	<ul style="list-style-type: none"> • >+2000 mV • Orange LED flashes regularly
	0 ... -2000 mV	Orange LED lights up ¹³	<ul style="list-style-type: none"> • <-2000 mV • Orange LED flashes regularly

Tab. 7: Output signal of the sensor when overdriven/underdriven

¹³ The displayed output signal must be multiplied by a factor of -1.

8.2 Special checks

8.2.1 Tightness of the membrane cap

- ▶ Unscrew the membrane cap from the sensor (see section 7, p. 25).
- ▶ Dry the outside of the membrane cap.
- ▶ Prepare the membrane cap (see section 4.2, p. 17).
- ▶ When screwing the membrane cap on, watch out for liquid escaping through the membrane.



If a drop forms on the outside of the membrane this is not a problem, as the membrane is hydrophilic.

If a flow of drops forms on the membrane:

- ▶ Use a new membrane cap.

If the sensor does not respond:

- ▶ Return the sensor to the supplier for checking.

8.2.2 Electronics

- ▶ Unscrew the membrane cap.
- ▶ Rinse the electrode finger with mains water.
- ▶ Using a clean cloth, carefully dry the electrode finger.
- ▶ Connect the sensor to the measuring and control device.
- ▶ Connect a suitable measuring device to the original sensor signal.
- ▶ Wait five minutes.
- ▶ Read the original sensor signal at the measuring device.
- ▶ Mark up the values that were read against the following target values:
 - Sensor (mV): approx. +/- 0 mV
 - Sensor (mA): approx. 4 mA
 - Sensor (Modbus): approx. 0 ppm or 0%

If the sensor signal approximately corresponds to the aforementioned value, the electronics can be provisionally regarded as OK.

If the measured value deviates significantly from the above value:

- ▶ Return the sensor to the supplier for checking.

8.2.3 Checking the zero point

- ✓ The electronics must have been tested and found to be OK.
- ▶ Prepare the sensor (see section 4.2, p. 17).
- ▶ Connect the sensor to the measuring and control device.
- ▶ Fill a glass beaker with mains water (without any disinfectant!).
- ▶ Stir the sensor round in the glass beaker for 30 seconds.
- ▶ Carefully put the sensor down obliquely in the glass beaker.
- ▶ Wait 30 minutes.
- ▶ Read the measuring value.

If the measuring value is close to the value 0, the zero point can provisionally be regarded as OK.

If the measuring value deviates significantly from zero:

- ▶ Perform maintenance on the sensor (see section 7, p. 25) and repeat the zero point test.



A freshly cleaned working electrode has a relatively high zero point. The sensor takes a few days to settle back to its lowest zero point.

If after maintenance has been performed on the sensor measuring value is not close to zero:

- ▶ Return the sensor to the supplier for checking.
- ↪ This completes the zero point checking.

8.2.4 Signal

- ✓ The zero point checking must have been performed successfully.
- ▶ Add the relevant disinfectant to the mains water in the glass beaker (see section 8.2.3, p. 38).
- ▶ Stir the sensor steadily round in the glass beaker for five minutes.
- ▶ Monitor the measuring value throughout this time.

If the measuring value increases, the sensor can provisionally be regarded as OK.

If the measuring value does not change:

- ▶ Perform maintenance on the sensor (see section 7, p. 25) and repeat the signal test.
- ↪ This completes the signal test. The sensor can be put back into use.

If after maintenance the sensor shows no response to the disinfectant:

- ▶ Return the sensor to the supplier for checking.

9 Technical data

Information on the technical data can be found at the following Internet address:

<https://www.reiss-gmbh.com/english/datasheets.htm>

10 Deinstallation and storage

To deinstall a sensor and prepare it for storage, proceed as follows:

- ▶ Unscrew the membrane cap.
- ▶ Remove G-holder from the membrane cap.
- ▶ Rinse the electrolyte out of the membrane cap and the G-holder with lukewarm tap water every 10 seconds.



The electrolyte must be completely removed. Otherwise long start-up/contact times may be expected during a recommissioning.

- ▶ Rinse the electrode finger with lukewarm mains water.
- ▶ Dry the membrane cap, G-holder and sensor body in a dust-free place.
- ▶ For protection, loosely screw the dry membrane cap onto the sensor body.
- ▶ Make sure that the membrane is not lying in contact with the working electrode.



▶ Store G-holder in original packaging.



If the membrane cap has been in use for one day or longer we recommend that it is not used when the sensor is recommissioned.

- ▶ Perform a change of membrane cap (see section 7.2, p. 26).

11 Disposal

- ▶ Comply with the local regulations on disposal.

12 Warranty

We grant a manufacturer's warranty of two years on the sensor body and the electronics, subject to correct handling. This excludes the membrane cap (wearing part), the electrolyte (expendable material) and service work to be carried out (cleaning of the parts coming into contact with the electrolyte, replacement of the reference electrode and cleaning the working electrode with special emery paper). If there is mechanical damage or the serial number is illegible, the warranty becomes void.

Returning a sensor for checking/factory reconditioning:

Shipments will be accepted only if they are returned carriage paid. Otherwise it will be returned to the sender.

Each return shipment must be accompanied by a completed declaration of clearance. This can be found at the following Internet address: <https://www.reiss-gmbh.com/forms/?lang=en>. In case of contamination or missing or not completed declaration of clearance, a cleaning fee will be charged.

On tested/overhauled sensors there is for expert use a warranty on the sensor body and the electronics of one year from the test-/overhaul date. If there is mechanical damage or the serial number is illegible, this warranty becomes void.

13 Liability disclaimer

The sensor is manufactured with great care and is subjected to a documented function test. Should any malfunctions occur in the sensor despite this, no liability claims may be lodged against the manufacturer for damages resulting from this malfunction.

14 Appendix

14.1 Chlorite analysis methods

14.1.1 Reagents and materials (recommended)

Reagents (recommended)	
Manufacturer: Tintometer GmbH	Liquid reagent DPD-1 buffer (blue)
	Liquid reagent DPD-1 reagent (green)
	Liquid reagent DPD-3 reagent (red)
	Acidifying GP tablets
	Neutralising tablets

Tab. 8: Reagents

Materials (recommended)
2 vessels, 10 ml ▶ Mark 1 (=measuring vessel) and 2 (=reaction vessel)
Pestle (plastic)
Foamer (for example: milk foamer)
Beaker, 250 ml
Timer
Photometer for determining free chlorine (Recommendation: photometer with recording range of 0.00 to 2.00 mg/l chlorine)

Tab. 9: Materials

14.1.2 Chlorite determination in the presence of chlorine dioxide

Before determining the chlorite, the chlorine dioxide must be removed from the water.

Removal of the chlorine dioxide from the sample of the water (A) using the foamer

- ▶ Flush 250 ml beaker with sample water.
- ▶ Fill the beaker with 50 ml sample water.
- ▶ Rinse out vessel 1 with sample water from the beaker.
- ▶ Fill vessel 1 with sample water from the beaker.
- ▶ Place filled vessel 1 to one side.
- ▶ Expel the chlorine dioxide out of the sample water in the beaker for 4 minutes using the foamer.
- ↪ The sample water (A) is prepared.

 The photometric chloride dioxide can be tested using the DPD-1 method to see whether the sample water (A) is free of chlorine dioxide.

Preparation of the photometer

- ▶ Switch on photometer.
- ▶ “Zero” the photometer with vessel 1 that is filled with sample water.
- ▶ Empty vessel 1.
- ▶ Careful rinse out vessel 1 with tap water.

 Chlorine dioxide residue in the vessel can lead to a fault when determining the chlorite. For this reason it is important to completely remove it.

- ▶ Place vessel 1 upside down on blotting paper.

Preparation of measurement

- ▶ Fill vessel 2 with sample water (A).
- ▶ Empty vessel 2.
- ▶ Drip 3 drops of DPD-3 reagent into vessel 2.
- ▶ Administer 10 ml sample water (A).
- ▶ Administer acidifying tablet.
- ▶ Crush and mix acidifying tablet with pestle.
- ▶ Wait 4 minutes (for a cold test <20 °C extend waiting time to 6 min).
- ▶ Administer neutralising tablet.
- ▶ Crush and mix neutralising tablet with pestle.

Measurement

- ▶ Drip 6 drops of DPD-1 buffer into vessel 1.
- ▶ Administer 2 drops of DPD-1 reagent.
- ▶ Slowly transfer contents of vessel 1 into vessel 2 (as bubble- and particle-free as possible).
- ▶ Measure vessel 1 in the photometer.
- ▶ Multiply the value by the **factor 0.48**.
- ↳ This will give the concentration in mg/l chlorite.

Reiss GmbH
Eisleber Str. 5
D - 69469 Weinheim
Germany